

Xinger® III

Doherty Combiner



Description

The X3DC19E2S is a low profile, high performance Doherty Combiner in a new easy to use, manufacturing friendly surface mount package. The X3DC19E2S is designed particularly for Doherty Amplifier applications, where tightly controlled phase and amplitude imbalance as well as low insertion loss are required for maximum and low power condition. It can be used in high power applications up to 200 watts.

Parts have been subjected to rigorous qualification testing and they are manufactured using materials with coefficients of thermal expansion (CTE) compatible with common substrates such as FR4, G-10, RF-35, RO4350 and polyimide. Produced with 6 of 6 RoHS compliant tin immersion finish

Features:

- 1930 - 1990 MHz
- High Power
- Low Amp Imbalance
- Very Low Loss
- Production Friendly
- Tape and Reel
- Lead Free

Electrical Specifications **

Frequency	Return Loss [1]	Insertion Loss [1]	Amplitude Imbalance [1]	Phase Imbalance [1]	Operating Temp.
MHz	dB Min	dB Max	dB Max	Degrees	°C
1930 – 1990	20	0.15	±0.12	90 ± 3.0	-55 to +95
	Return Loss [2]	Insertion Loss [2]	Port Extension [3]	Power [4]	ΘJC
	dB Min	dB Max	Degrees	Avg. CW Watts	°C/Watt
	20	0.20	9	200	27

**Specification based on performance of unit properly installed on Anaren Test Board

[1] At maximum power condition, Doherty combiner functions as an equal-split power combiner.

[2] At low power condition, Doherty combiner functions as a 100Ω to 50Ω impedance transformer.

[3] There are short 50 ohm lines associated with input ports of 9° at 1960MHz. Details in page 2.

Mechanical Outline

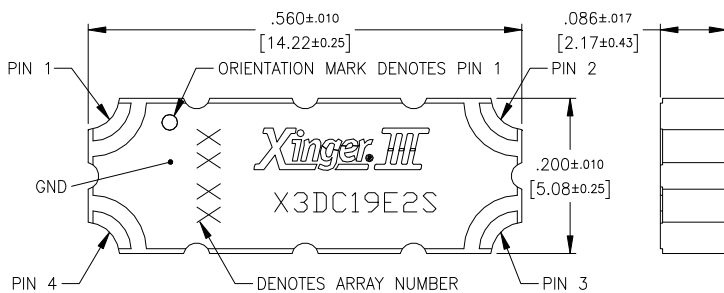

Dimensions are in Inches [Millimeters]
X3DC19E2S Mechanical Outline

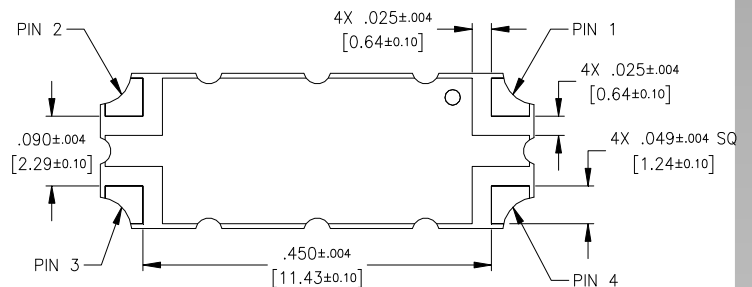

Tolerances are Non-Cumulative

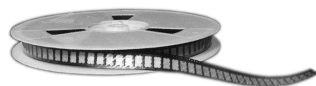

Doherty Amplifier Configuration

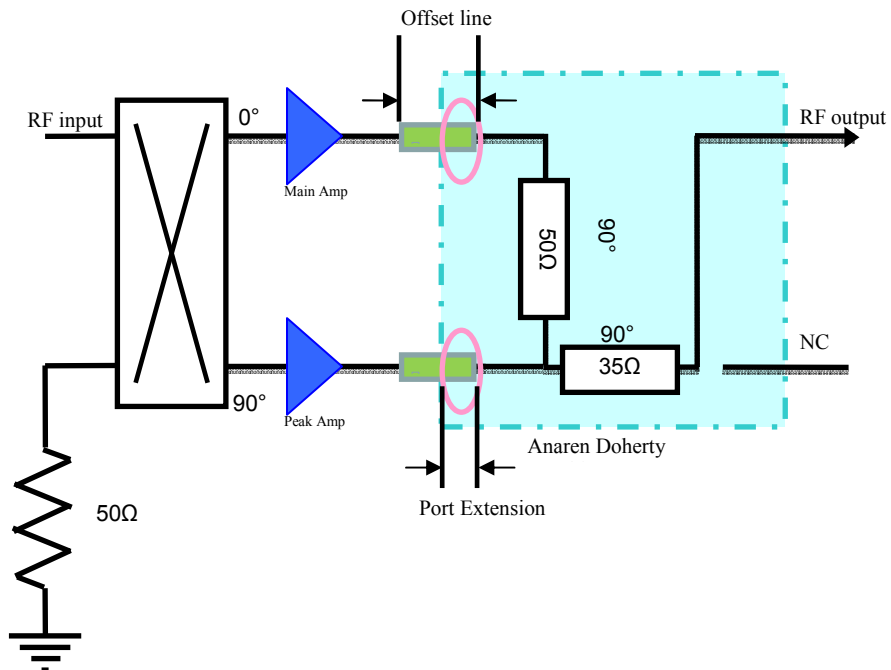

Doherty Combiner Pin Configuration

The X3DC19E2S has an orientation marker to denote Pin 1. Once port one has been identified the other ports are known automatically. Please see the chart below for clarification:

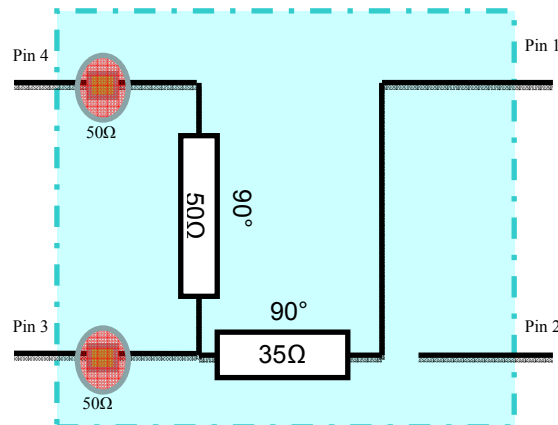

Pin 1	Pin 2	Pin 3	Pin 4
Combining Port	Not Used	Peak Amp Port	Main Amp Port

There are inevitably short lines associating with input ports in some high frequency band parts. The length of the short line is specified as electrical length at center frequency and noted as port extension in this datasheet. The designer should take this length into the consideration to optimize the offset line length.

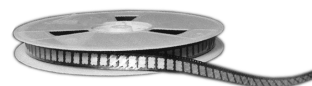

Typical Performance (-55°C, 25°C, 95°C) : 1930 – 1990 MHz

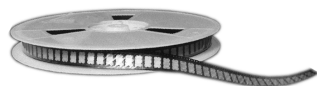
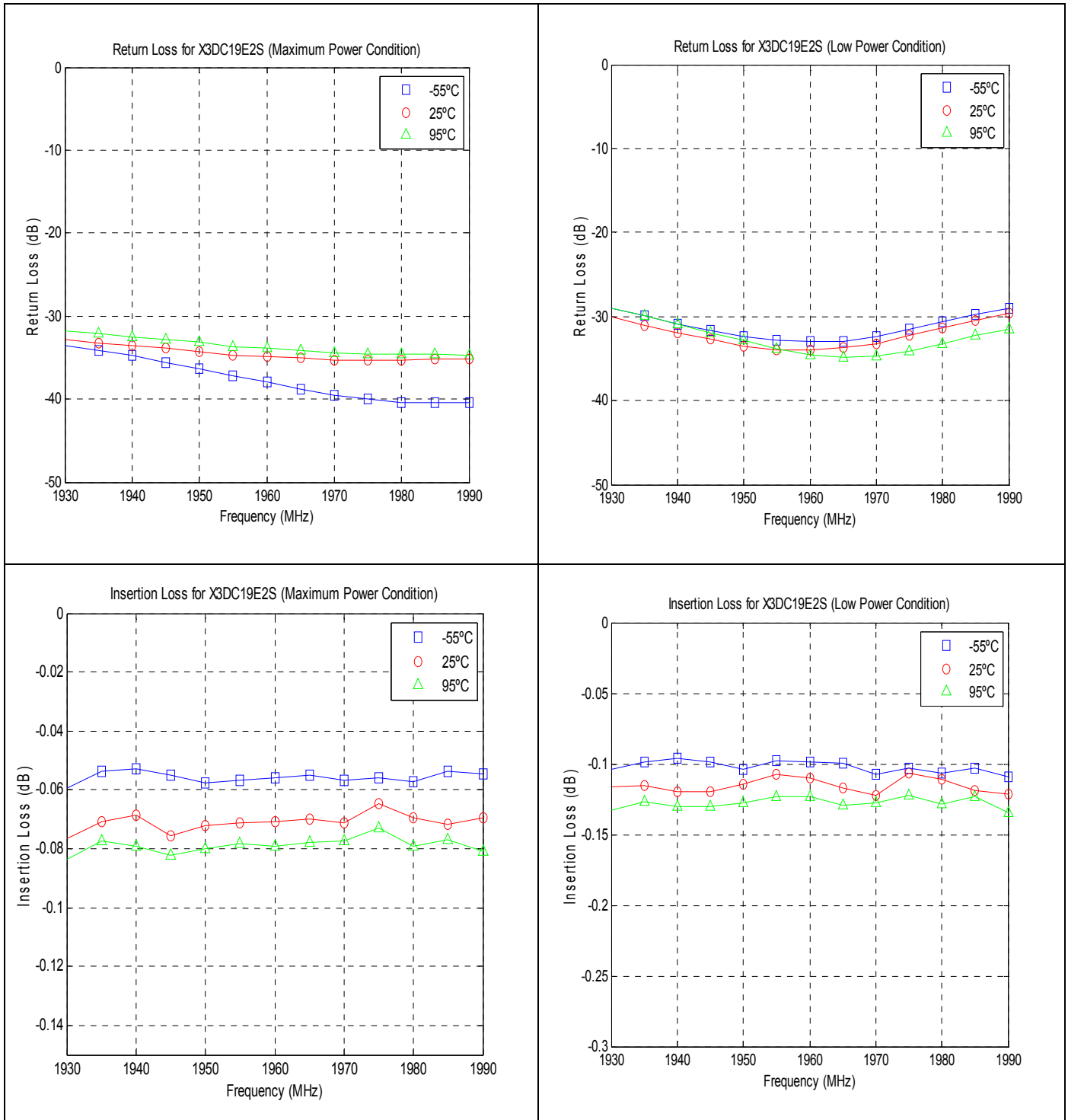

Typical Performance (-55°C, 25°C, 95°C): 1930 – 1990 MHz

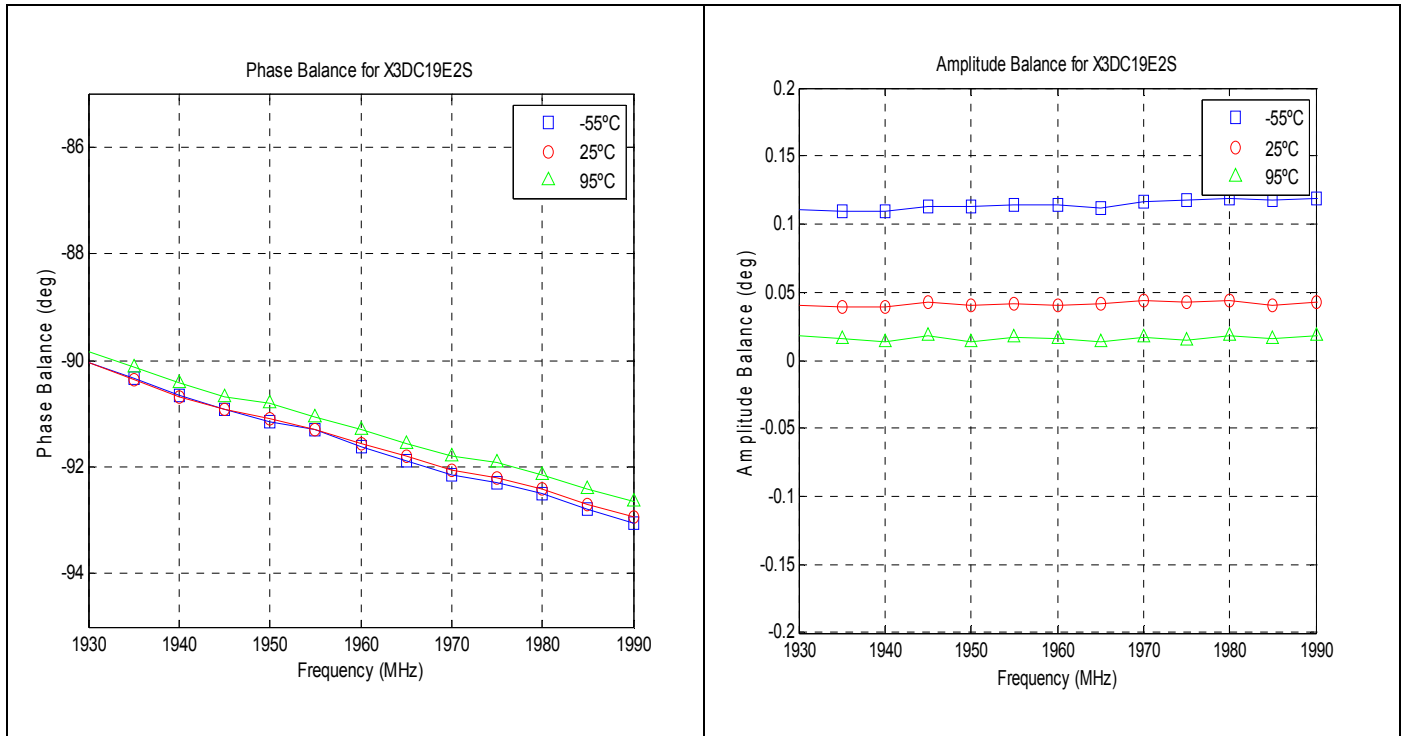

USA/Canada: (315) 432-8909
Toll Free: (800) 411-6596
Europe: +44 2392-232392

Available on Tape and Reel for Pick and Place Manufacturing.

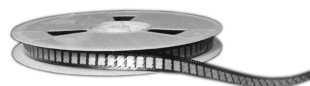

Anaren®
What'll we think of next?™

Definition of the Specifications

To guarantee the part performance in Doherty architecture, the part is specified in Doherty operation for maximum power condition and low power condition. The following specification definition assumes the extra port extension is deembedded from the raw S parameter and the parts is measured with Pin n connected to Port n (where n=1, 2, 3, 4).

- Maximum power condition**

Under the maximum power condition, the symmetrical Doherty architecture requires main amplifier and peak amplifier to work at full capacity with the optimum termination (50 Ω). The two amplifiers should deliver RF power of equal magnitude and 90 degree phase difference. Doherty combiner functions as a coherent power combiner and supplies the 90 degree phase compensation. The following specification is defined with 50 Ω port impedance at three ports for this condition.

Parameter	Definition	Mathematical Representation
Return Loss	The impedance match at the combining port to a 50Ω system.	$20\log S_{11} $
Insertion Loss	The combined power divided by the sum of input power under the perfect combining condition.	$10\log (S_{13} ^2 + S_{14} ^2)$
Phase Imbalance	The phase difference between Peak-Combined path and Main-Combined path at $\omega_c = 1960\text{MHz}$.	Phase ($S_{14}(\omega_c)$) – Phase ($S_{13}(\omega_c)$)
Amplitude Imbalance	The magnitude difference between Peak-Combined path and Main-Combined path.	$\frac{(20\log S_{14} - 20\log S_{13})}{2}$

- Low power condition**

Under low power condition, the Doherty operation turns off peak amplifier and requires main amplifier to be terminated with double of the optimum impedance (100 Ω). With the peak port open, Doherty combiner servers as an impedance transformer transforming 50 Ω at combining port to 100 Ω at main amplifier port. The following specification is defined under the port impedance condition of Port 1 (Combining Port) 50 Ω, Port 4 (Main Amp Port) 100 Ω and Port 3 (Peak Amp Port) open.

Parameter	Definition	Mathematical Representation
Return Loss	The impedance match of the 50 to 100 Ω transformer.	$20\log S_{11} $
Insertion Loss	The output power divided by input power.	$20\log S_{41} $

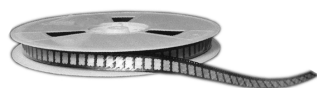

Packaging and Ordering Information

Parts are available in reel. Packaging follows EIA 481-2. Parts are oriented in tape and reel as shown below. Minimum order quantities are 2000 per reel.

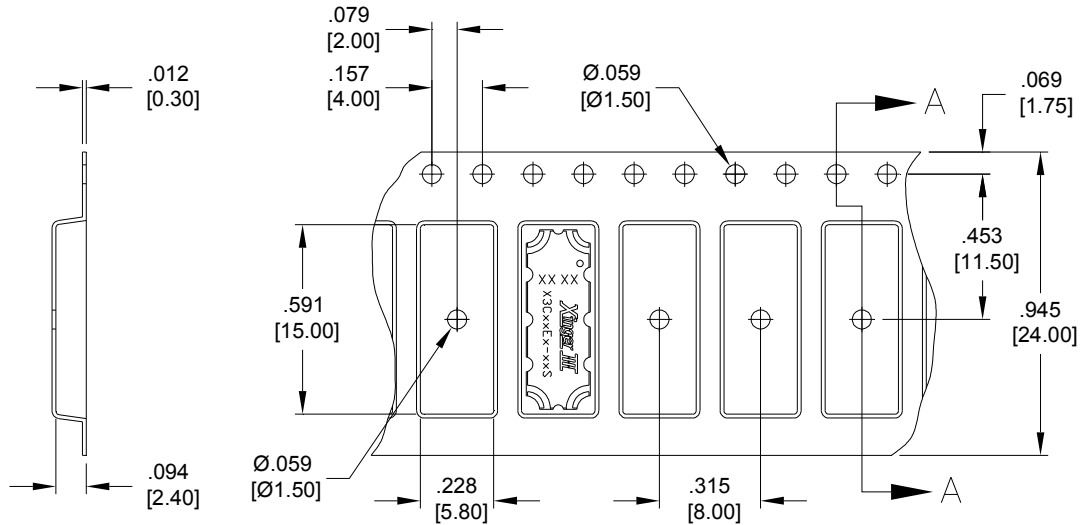

SECTION A-A

Direction of Part Feed (Unloading)

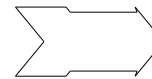

To ensure proper electrical and thermal performance there must be a ground plane with 100% solder connection underneath the part oriented as shown with text facing up

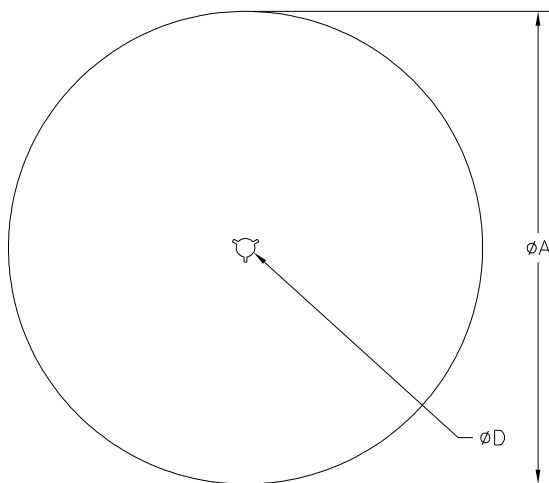
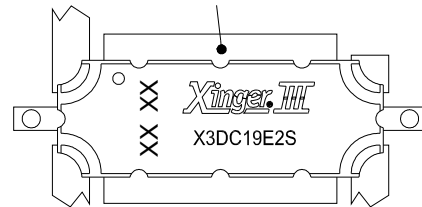
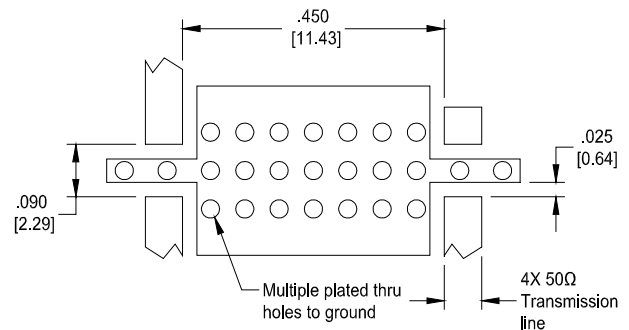

TABLE 1	
REEL DIMENSIONS (inches [mm])	
ØA	13.0 [330.0]
B	.945 [24.0]
ØC	4.017 [102.03]
ØD	0.512 [13.0]



Dimensions are in Inches [Millimeters]
X3DC19E2S Mounting Footprint

USA/Canada: (315) 432-8909
Toll Free: (800) 411-6596
Europe: +44 2392-232392

Available on Tape and Reel for Pick and Place Manufacturing.

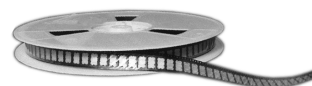

Anaren®
What'll we think of next?™

Mouser Electronics

Authorized Distributor

Click to View Pricing, Inventory, Delivery & Lifecycle Information:

[Anaren:](#)

[X3DC19E2S](#)